

November 16, 2007

Mr. Ron Lamberty
American Coalition for Ethanol
5000 S. Broadband Lane, Suite 224
Sioux Falls, SD 57108

Dear Mr. Lamberty:

Subject: Final Report Entitled "Optimal Ethanol Blend-Level Investigation"; EERC Fund 9495

Enclosed please find the subject final report. If you have any questions or comments, I can be reached by phone at (701) 777-2982, by fax at (701) 777-5181, or by e-mail at taulich@undeerc.org.

Sincerely,

Ted R. Aulich
Senior Research Manager

TRA/nfp

Enclosure

OPTIMAL ETHANOL BLEND-LEVEL INVESTIGATION

Final Report

(for the period of December 15, 2006, through December 31, 2007)

Prepared for:

Ron Lamberty

American Coalition for Ethanol
5000 S. Broadband Lane, Suite 224
Sioux Falls, SD 57108

Prepared by:

Richard E. Shockey
Ted R. Aulich

Energy & Environmental Research Center
University of North Dakota
15 North 23rd Street, Stop 9018
Grand Forks, ND 58202-9018

Bruce Jones
Gary Mead
Paul Steevens

Minnesota Center for Automotive Research
Minnesota State University, Mankato
Trafton Science Center 205E
Mankato, MN 56001

EERC DISCLAIMER

LEGAL NOTICE This research report was prepared by the Energy & Environmental Research Center (EERC), an agency of the University of North Dakota, as an account of work sponsored by the U.S. Department of Energy and the American Coalition for Ethanol (ACE). Because of the research nature of the work performed, neither the EERC nor any of its employees makes any warranty, express or implied, or assumes any legal liability or responsibility for the accuracy, completeness, or usefulness of any information, apparatus, product, or process disclosed, or represents that its use would not infringe privately owned rights. Reference herein to any specific commercial product, process, or service by trade name, trademark, manufacturer, or otherwise does not necessarily constitute or imply its endorsement or recommendation by the EERC.

TABLE OF CONTENTS

LIST OF FIGURES	iii
LIST OF TABLES	iv
EXECUTIVE SUMMARY	iv
1.0 INTRODUCTION.....	1
2.0 TEST MATRIX DESIGN	2
2.1 Base Test Fuels	2
2.1.1 EPA Tier 2 EEE Gasoline.....	2
2.1.2 Undenatured Fuel-Grade Ethanol	3
2.2 Undenatured Fuel-Grade Ethanol–Tier 2 EEE Gasoline Fuel Blends.....	3
2.3 Test Vehicles	3
3.0 TESTING PROCEDURES AND EQUIPMENT	7
3.1 Fuel Tank Flushing and Fuel Change-Out Procedure	7
3.2 Engine Management System “Learning” Training.....	8
3.3 Wide-Open-Throttle Full-Load Horsepower Testing.....	9
3.4 Fuel Economy and Emission Testing	10
3.5 SuperFlow AC Motor-Driven Chassis Dynamometer.....	10
3.6 Critical Flow Venturi.....	11
3.7 Drive Cycle and Driver’s Trace Monitor.....	11
3.8 FTP-75 Driving Cycle	11
3.9 HWFET Driving Cycle.....	12
4.0 GAS ANALYZERS	13
4.1 Hydrocarbons.....	13
4.2 Carbon Monoxide and Carbon Dioxide.....	13
4.3 Oxides of Nitrogen (NO _x).....	14
5.0 FUEL ECONOMY TEST RESULTS.....	14
5.1 Calculated Fuel Economy	14
5.2 Toyota Camry Fuel Economy.....	14
5.3 Chevrolet Impala (non-flex fuel) Fuel Economy.....	16
5.4 Chevrolet Impala (flex fuel) Fuel Economy	16
5.5 Ford Fusion Fuel Economy	16
5.6 Fuel Economy Improved	18
6.0 EMISSION TEST RESULTS: FTP-75 AND HWFET EMISSIONS	18
7.0 DISCUSSION AND CONCLUSIONS.....	19
8.0 REFERENCES.....	22

LIST OF FIGURES

1	Ford Fusion	5
2	Toyota Camry	6
3	Chevrolet Impala	6
4	Chevrolet Impala (flex fuel)	7
5	Mustang chassis dynamometer.....	10
6	SuperFlow AC motor-driven chassis dynamometer	11
7	Federal Test Procedure 75	12
8	Highway fuel economy test.....	13
9	Calculated fuel economy	15
10	2007 Toyota Camry, 2.4-L engine, highway fuel economy.....	15
11	2007 Chevrolet Impala (non-flex fuel), 3.5-L engine, highway fuel economy	16
12	2007 Chevrolet Impala (flex fuel), 3.5-L engine fuel economy	17
13	2007 Ford Fusion, 2.3-L engine, highway fuel economy	17
14	Fuel Economy Improvement, E20 and E30 vs. Tier 2 gasoline.....	19

LIST OF TABLES

1	Tier 2 Gasoline Specifications	4
2	Undenatured Fuel-Grade Ethanol–Tier 2 Gasoline Blend Fuel Properties	5
3	Engine Specs and EPA Fuel Economics	7
4	Tier 2 Light-Duty, Full-Useful-Life Exhaust Emission Standards	19
5	FTP-75 and HWFET Emissions and Fuel Economy for Toyota Camry.....	20
6	FTP-75 and HWFET Emissions and Fuel Economy for Chevrolet Impala	20
7	FTP-75 and HWFET Emissions and Fuel Economy for Chevrolet Impala (flex fuel).....	21
8	FTP-75 and HWFET Emissions and Fuel Economy for Ford Fusion	21

OPTIMAL ETHANOL BLEND-LEVEL INVESTIGATION

EXECUTIVE SUMMARY

The University of North Dakota Energy & Environmental Research Center (EERC) and the Minnesota Center for Automotive Research (MnCAR) conducted vehicle fuel economy and emission testing on four 2007 model vehicles. The vehicles tested included a Chevrolet Impala flex-fuel and three non-flex-fuel vehicles: a Ford Fusion, a Toyota Camry, and a Chevrolet Impala. This investigation utilized a range of undenatured ethanol–Tier 2 gasoline blend levels from 0% to 85%. The primary objective of the investigation was to investigate the possible existence of a fuel economy-based optimal ethanol blend level, as determined by the Highway Fuel Economy Test (HWFET), at which measured miles per gallon is greater than predicted based strictly on per-gallon fuel Btu content. A secondary objective was to acquire HWFET hot-start tailpipe emission data for all surveyed fuels. Following optimal blend-level determination, cold-start emissions, as determined by Federal Test Procedure 75 (FTP-75), were determined on the optimal blend-level and Tier 2 gasoline.

HWFET testing on ethanol blend levels of E20 in the flex-fuel Chevrolet Impala, E30 in the non-flex-fuel Ford Fusion and Toyota Camry, and E40 in the non-flex-fuel Chevrolet Impala resulted in measured miles-per-gallon fuel economy greater than predicted based on per-gallon fuel Btu content. It is notable that the non-flex-fuel vehicles obtained greater fuel economy at higher blends of ethanol than the unleaded gasoline. In the case of the flex-fuel Chevrolet Impala, the highway fuel economy was greater than calculated for all tested blends, with an especially high peak at E20. While only three non-flex-fuel vehicles were tested in this study, there is a strong indication that non-flex-fuel vehicles operated on optimal ethanol blend levels, which are higher than the standard E10 blend, can obtain better fuel mileage than on gasoline. The Ford Fusion and Toyota Camry obtained a HWFET mileage on E30 of 1% greater than on Tier 2 gasoline; the flex-fuel Chevrolet Impala showed a HWFET mileage of 15% on E20 better than Tier 2 gasoline, as shown in Figure ES-1.

Exhaust emission values for nonmethane organic gases (NMOG), nitrogen oxides (NO_x), and carbon monoxide (CO) obtained from both the FTP-75 and the HWFET driving cycles were at or below U.S. Environmental Protection Agency (EPA) Tier 2, light-duty vehicle, Bin 5 levels of 0.090, 0.07, and 4.2 grams/mile, respectively, for all vehicles tested, with one exception. The flex-fuel Chevrolet Impala exceeded the NMOG standard for the FTP-75 on E20 and Tier 2 gasoline.

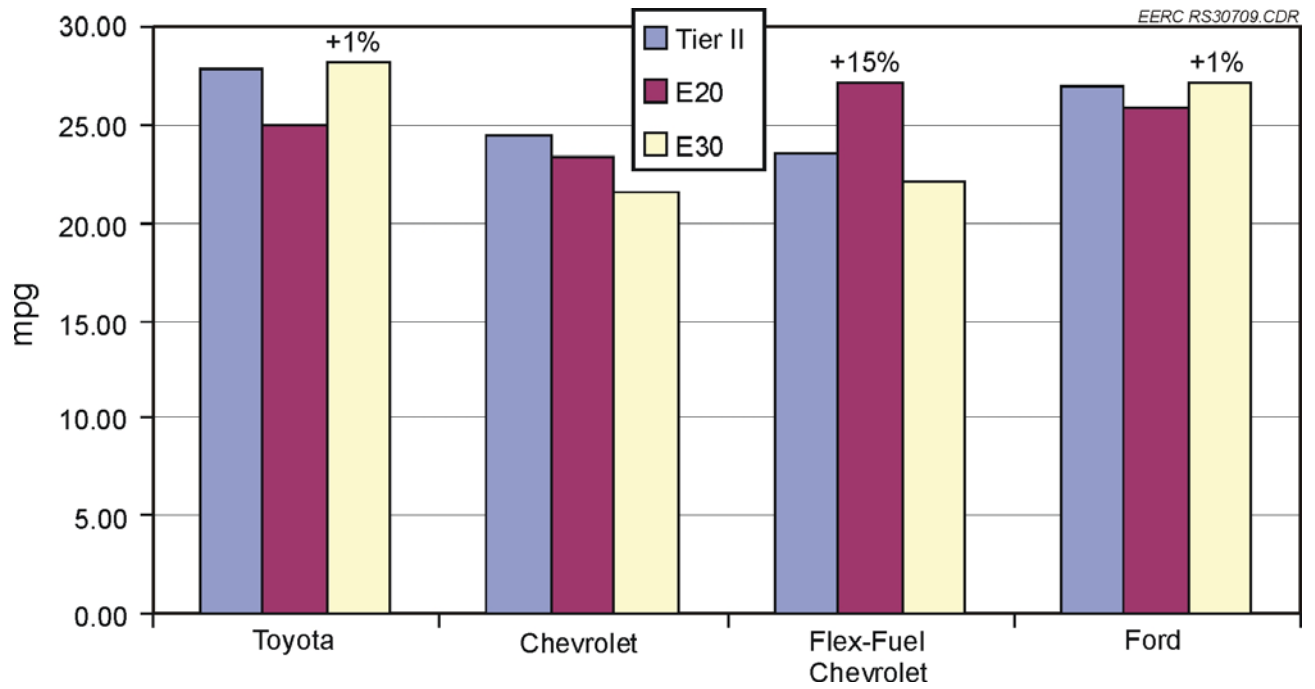

Figure ES-1. Highway fuel economy improvement, E20 and E30 vs. Tier 2 gasoline.

OPTIMAL ETHANOL BLEND-LEVEL INVESTIGATION

1.0 INTRODUCTION

A large body of vehicle fuel economy and emission testing has been done on various ethanol–gasoline fuel blends, resulting in wide variety of data. Often, careful analysis of the data reveals some variance in the testing procedures. This investigation by the Energy & Environmental Research Center (EERC) is designed to minimize the effects of test procedure-related variables, thereby maximizing the potential for accurately assessing the fuel economy and emission impacts of incremental ethanol addition to gasoline. To ensure optimal correlation between fuel chemistry inputs and performance and emission outputs, fuels utilized were gasoline conforming to U.S. Environmental Protection Agency (EPA) Tier 2 EEE specifications and undenatured fuel-grade ethanol. To ensure against narrow applicability of results, vehicles utilized included three non-flex-fuel, late model vehicles and one flex-fuel vehicle from General Motors, Toyota, and Ford. To ensure against potentially confounding the effects of environmental factors, all testing was conducted on a state-of-the-art, fully instrumented SuperFlow AC motor-driven chassis dynamometer coupled with a California Analytical Instruments analytical exhaust emission bench and a Mustang computer-controlled chassis dynamometer.

EPA requires all automobile manufacturers that sell light-duty vehicles in the United States to provide vehicle exhaust emissions and city fuel economy values, as determined by the EPA Federal Test Procedure (FTP-75) driving cycle test. The vehicle exhaust emissions must meet or be less than Tier 2 light-duty exhaust emission standards. In addition, the vehicle highway fuel economy must be determined by the EPA Highway Fuel Economy Test (HWFET). The four vehicles tested in this investigation were subjected to the EPA protocol related to FTP-75 and HWFET. FTP-75 comprises cold-start, transition, and hot-start phases. Because 80%–90% of tailpipe emissions occur during cold-start episodes, prior to the point at which a vehicle’s exhaust emission control catalytic converter is heated to its operating temperature, the cold-start phase allows evaluation of any possible emission irregularities that may not be observed during hot-start tests.

The EPA HWFET evaluates fuel consumption and hot-start and operating emissions. To ensure maximum data accuracy, each ethanol blend-level evaluation was performed in triplicate. For each vehicle, testing typically commenced at an ethanol blend level of 0%, after which blend level was increased in 10% increments up to 70%, and then to 85%, for a total of up to nine blend-level evaluations per vehicle. When one blend level was switched to the next, old fuel was pumped from the tank, the tank flushed twice, new fuel was added, and the vehicle was road-tested by driving the vehicle approximately 25 miles on both highway and city roads to ensure that the vehicle computer acquired adequate data to “learn” the optimal air-to-fuel requirements of the new fuel. Vehicle fuel trim data were monitored to ensure the fuel had been “learned.” After the vehicle had “learned” the fuel, it was then tested on the Mustang dynamometer. The vehicle was tested to see if the fuel injectors could supply adequate fuel under high-load conditions. If the vehicle could not “learn” the new fuel, either in the road test or the Mustang dynamometer test, as indicated by an engine fault code display, the ethanol blend level of the fuel was reduced to 5% less to determine if the vehicle could “learn” a lesser ethanol blend-level

fuel. The highest ethanol blend level for each fuel was that on which the vehicle could operate with no engine fault code display. The engine fault code is triggered because of the inability of the fuel injector system to deliver sufficient fuel for normal operation of the engine. All four vehicles operated on ethanol blendlevels of at least 45% without engine fault code display.

When a vehicle had successfully “learned” an ethanol blend level, it was then subjected to a HWFET on the SuperFlow AC motor-driven chassis dynamometer to obtain highway fuel economy and emission data. The highway fuel economy data were used to determine if there was an optimum ethanol blend level at which the vehicle attained a better-than-calculated fuel economy. The optimum ethanol blend level was determined by plotting the HWFET fuel economy against the calculated economy. If several ethanol blend-level HWFET fuel economies were higher than the calculated fuel economy, the one with the greatest difference was selected as the optimum ethanol blend level for that vehicle.

In the HWFET testing, ethanol blend levels of E20 in the flex-fuel Chevrolet Impala, E30 in the non-flex-fuel Ford Fusion and Toyota Camry, and E40 in the non-flex-fuel Chevrolet Impala resulted in miles-per-gallon fuel economy greater than predicted based on per-gallon fuel Btu content and in some cases, better than gasoline. An FTP-75 was run (in triplicate) on all the test vehicles at these ethanol blend levels.

2.0 TEST MATRIX DESIGN

2.1 Base Test Fuels

2.1.1 EPA Tier 2 EEE Gasoline

The Tier 2 Vehicle and Gasoline Sulfur Program (1) is a landmark program that affects every new passenger vehicle and every gallon of gasoline sold in the United States. By designing cleaner cars that run on cleaner fuels, the result is cleaner air. The program is a series of “firsts.” For the first time:

- Sport utility vehicles (SUVs), pickups, vans, and even the largest personal passenger vehicles are subject to the same national emission standards as cars.
- Vehicles and the fuels they use are treated as a system, so the cleaner vehicles will have the low-sulfur gasoline they need to run their cleanest.
- New emission standards apply to all light vehicles, regardless of whether they run on gasoline, diesel fuel, or alternative fuels.

The Tier 2 Vehicle and Gasoline Sulfur Program is part of a series of major initiatives that will reduce emissions from passenger vehicles, highway trucks and buses, and nonroad diesel equipment. The result will be reduced emissions, cleaner air, and improved human health. Gasoline purchased at the pump by a consumer is a highly variable commodity. While it must meet certain federally mandated criteria, such as Reid vapor pressure, octane rating, distillation temperature range, etc., the chemical composition can vary widely. Every chemical has different

combustion properties, oxidation pathways, combustion end products, etc. The emission data from one gasoline very likely will differ from the data gathered from a different gasoline. To ensure against fuel variability-related impacts, a standardized fuel is required. EPA Tier 2 EEE gasoline is the standardized fuel for vehicle certification of fuel economy and tailpipe emissions. Every vehicle sold in the United States is required to use Tier 2 EEE gasoline for emission and fuel economy testing. Tier 2 gasoline used in the optimal ethanol blend investigation was purchased from Haltermann Products, Channelview, Texas. Table 1 lists the specification requirements of the fuel.

2.1.2 Undenatured Fuel-Grade Ethanol

Fuel-grade ethanol is typically denatured with 2%–5% natural gasoline. Denaturing agents, such as natural gasoline, cannot be removed from ethanol without expensive and extraordinary measures. This ensures against fuel-grade ethanol consumption and avoidance of taxation by the federal government. Natural gasoline is a mixture of hydrocarbons, mostly pentanes and heavier hydrocarbons, extracted from natural gas. Undenatured fuel-grade ethanol was used for the blending so that no extraneous organic carbon was included in the final blend. The Tier 2 EEE fuel has a reported weight fraction of carbon in the analysis. The carbon fraction is utilized in the emission calculations. Carbon from denaturants would complicate determination of the weight fraction of carbon in the blended fuel. The undenatured fuel-grade ethanol used for blending was purchased from Alchem, Ltd., Grafton, North Dakota, a dry-grind corn ethanol producer. Alchem markets denatured fuel-grade ethanol conforming to ASTM International D4806-07 “Standard Specification for Denatured Fuel Ethanol for Blending with Gasolines for Use as Automotive Spark-Ignition Engine Fuel.”

2.2 Undenatured Fuel-Grade Ethanol–Tier 2 EEE Gasoline Fuel Blends

Eight undenatured fuel-grade ethanol and Tier 2 EEE gasoline compositions, from E10 to E85, on a volume/volume basis, were blended for initial screening in this investigation (Table 2).

2.3 Test Vehicles

Four 2007 vehicles, with automatic transmissions, were tested in this study:

- A Ford Fusion with a 2.3-liter engine with approximately 5000 miles on the odometer (Figure 1).
- A Toyota Camry with a 2.4-liter engine with approximately 7000 miles on the odometer (Figure 2).
- A Chevrolet Impala with a 3.5-liter engine with approximately 31,000 miles on the odometer (Figure 3).
- A Chevrolet Impala (flex fuel) with a 3.5-liter engine with approximately 7000 miles on the odometer (Figure 4).

Table 1. Tier 2 Gasoline Specifications

PRODUCT: EPA TIER II EEE **Batch No.:** VD0321LT10
FEDERAL REGISTER **Shipment No:** MTS
PRODUCT CODE: HF437 **Tank No.:** 105
Analysis Date: 4/11/2007
Shipment Date:

TEST	METHOD	UNITS	FED Specs		HALTERMANN Specs			RESULTS
			MIN.	MAX.	MIN.	TARGET	MAX.	
Distillation – IBP	ASTM D86	°F	75	95	75		95	78
5%		°F						112
10%		°F	120	135	120		135	124
20%		°F						143
30%		°F						167
40%		°F						198
50%		°F	200	230	200		230	222
60%		°F						233
70%		°F						245
80%		°F						266
90%		°F	305	325	305		325	319
95%		°F						334
Distillation – EP		°F		415			415	392
Recovery		vol%				Report		98.3
Residue		vol%				Report		1.0
Loss		vol%				Report		0.7
Gravity	ASTM D4052	°API	58.7	61.2	58.7		61.2	59.1
Density	ASTM D4052	kg/L			0.734		0.744	0.742
Reid Vapor Pressure	ASTM D323	psi	8.7	9.2	8.7		9.2	9.0
Reid Vapor Pressure	ASTM D5191	psi	8.7	9.2	8.7		9.2	9.10
Carbon	ASTM D3343	wt fraction				Report		0.0000
Carbon	ASTM E191	wt fraction				Report		0.8637
Hydrogen	ASTM E191	wt fraction				Report		0.1343
Hydrogen/Carbon Ratio	ASTM E191	mole/mole				Report		1.853
Oxygen	ASTM D4815	wt%					0.05	<0.05
Sulfur	ASTM D5453	wt%	0.0015	0.0080	0.0025		0.0035	0.0028
Lead	ASTM D3237	g/gal		0.05			0.01	<0.01
Phosphorus	ASTM D3231	g/gal		0.005			0.005	<0.0008
Composition, aromatics	ASTM D1319	vol%		35.0			35.0	29.4
Composition, olefins	ASTM D1319	vol%		10.0			10.0	0.6
Composition, saturates	ASTM D1319	vol%				Report		70.0
Particulate Matter	ASTM D5452	mg/L					1	0.4
Oxidation Stability	ASTM D525	minutes			240			>1000
Copper Corrosion	ASTM D130						1	1
Gum Content, washed	ASTM D381	mg/100 mL					5	<0.5
Fuel Economy Numerator/C Density	ASTM E191				2401		2441	0
C Factor	ASTM E191					Report		0.0000
Research Octane Number	ASTM D2699		93.0		96.0			96.6
Motor Octane Number	ASTM D2700					Report		88.0
Sensitivity			7.5		7.5			8.6
Net Heating Value, Btu/lb	ASTM D3338	Btu/lb				Report		0
Net Heating Value, Btu/lb	ASTM D240	Btu/lb				Report		18427
Color	VISUAL					Report		CLEAR

APPROVED BY: _____

ANALYST HVD

Table 2. Undenatured Fuel-Grade Ethanol–Tier 2 Gasoline Blends Fuel Properties

Blend	RVP ¹	Specific Gravity ²
Tier 2 Gasoline	9.07	0.7404
E10	10.11	0.7443
E20	9.91	0.7503
E30	9.76	0.7542
E40	9.30	0.7602
E50	8.92	0.7651
E60	7.82	0.7730
E70	7.38	0.7789
E85	3.28	0.7918
Fuel-Grade Ethanol (undenatured)	2.54	0.7968

¹ ASTM Method D323 for Reid vapor pressure.

² ASTM Method D4052 for density and relative density.



Figure 1. Ford Fusion.

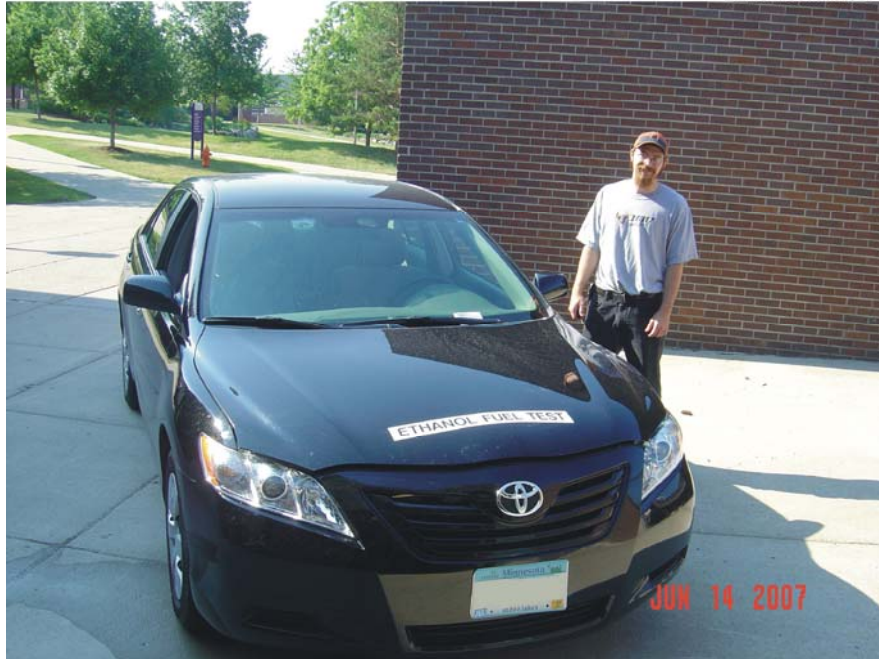

Figure 2. Toyota Camry.



Figure 3. Chevrolet Impala.



Figure 4. Chevrolet Impala (flex fuel).

Vehicle specifications and EPA-determined fuel economy are shown in Table 3.

Table 3. Engine Specs and EPA Fuel Economics

	Engine Displacement, liters	Compression Ratio	EPA City Fuel Economy, mpg	EPA Highway Fuel Economy, mpg	Horsepower @ rpm	Torque, lb-ft @ rpm
Toyota Camry	2.4	9.8 to 1	24	32	158@6000	161@4000
Chevrolet Impala	3.5	9.8 to 1	21	31	211@5800	214@4000
Chevrolet Impala, flex fuel	3.5	9.8 to 1	21	31	211@5800	214@4000
Ford Fusion	2.3	9.1 to 1	23	31	160@6250	156@4250

3.0 TESTING PROCEDURES AND EQUIPMENT

3.1 Fuel Tank Flushing and Fuel Change-Out Procedure

In order to ensure that the fuel tested was not contaminated with fuel currently in the fuel system, it was necessary to thoroughly flush the fuel system. The procedure used, entitled “Fuel Tank Flushing Procedure,” is recommended by the Coordinated Research Council. The fuel tank was completely drained through the fuel line Schrader valve by activating the vehicle fuel pump. Four gallons of the test fuel was added to the vehicle fuel tank, and the vehicle was started and idled for 2 minutes. The fuel tank was again completely drained, and 4 gallons of test fuel was

added. The vehicle was started and idled for a total of 2 minutes. From approximately 15 seconds into the idle, for a period of 30 seconds, the rear end of the vehicle was rocked from side to side. Again, the fuel tank was completely emptied through the Schrader valve using the vehicle fuel pump. Eight gallons of test fuel was then added to the vehicle fuel tank for the subsequent learning and dynamometer testing.

3.2 Engine Management System “Learning” Training

Virtually all vehicles manufactured since the early 1980s utilize a computer to monitor and adjust specific engine parameters that affect fuel economy and tailpipe emissions. These systems attempt to adjust the amount of fuel delivered and ignition timing to the optimal level for performance, drivability, and emissions.

The air/fuel ratio (AFR) on all cars utilizing computer controls is primarily controlled through the interaction of the fuel injector, oxygen sensor in the exhaust system, and engine computer. While the vehicle is cruising or driving under light to moderate load, the engine control unit (ECU) tries to target a stoichiometric AFR. A stoichiometric AFR means that there is a perfect mixture of air and fuel so that when combustion takes place, the only products are CO₂ and water. The AFR is controlled through the amount of time the fuel injector is turned on by the ECU; the longer it is on, the more fuel is added to achieve a stoichiometric AFR. The injector “on-time” is controlled by the ECU based on many sensor inputs. However, the primary sensor used is the oxygen sensor.

The oxygen sensor is placed in the exhaust stream of the vehicle between the engine and the catalytic converter. It sends a signal to the ECU that is a function of the amount of oxygen in the exhaust. If there is not enough fuel in the air–fuel mixture entering the engine, the oxygen content of the exhaust is high, indicating a “lean” AFR. A signal is sent to the ECU requesting more fuel. If the oxygen content of the exhaust is low, the air–fuel mixture is considered “rich.” A signal is sent to the ECU requesting less fuel. The signals sent to the ECU allow fuel adjustment to occur approximately once a second. This is referred to as “closed-loop operation.”

However, there are times when the engine requires a mixture that is not stoichiometric. These conditions include, but are not limited to, a cold start and/or a wide-open throttle situation, which requires a richer mixture than a light cruising or idle condition, which requires a leaner mixture to obtain improved fuel economy. Also, the oxygen sensor does not generate a signal until it has reached operating temperature, which can take several minutes of engine operation to attain. During these times, the oxygen sensor signal cannot be used by the ECU for engine control.

The ECU must, therefore, estimate how much time to hold the injectors open during those conditions. The ECU has an internal “target fuel map,” based on gasoline, that has been generated by the automobile manufacturer. The ECU uses the target fuel map to optimize the AFR for specific engine operating conditions. Ethanol contains oxygen, and when it is added to the gasoline and combusted, the oxygen content of the exhaust increases, indicating a “lean” AFR. The amount of injector on-time required changes for a specific operating condition.

During closed-loop operation of the ECU, the interaction of the oxygen sensor and fuel injectors is adjusted to the oxygen content of various ethanol blends to obtain the stoichiometric AFR. However, during open-loop conditions, the ECU varies the amount of time the fuel injector is turned on based on the target fuel map held in the ECU program. This program has been developed for gasoline and E10. Those values will not deliver the proper amount of fuel with higher ethanol blends. This is where the short-term and long-term fuel trim values come into play.

If more correction than normal is needed, as determined by the ECU target fuel map, the ECU uses the short-term fuel trim strategy option to compensate. The ECU short-term fuel trim programming allows the ECU to adapt and adjust the injection duration quickly, delivering the correct amount of fuel. When higher ethanol blends are used, the initial output of the ECU results in a lean mixture. When a specific injector on-time is commanded, the oxygen sensor signals a change in operation, by changing either to a rich or lean AFR. However, if the response is not what the ECU anticipates, the injection timing is adjusted until the expected response is observed. This phenomena is referred to as “learning.” Short-term fuel trim is a very fast-responding adjustment, while long-term fuel trim adjusts via the “target fuel map” stored in the ECU.

The procedure followed to “learn” each new ethanol blend involved starting each vehicle a minimum of three times, after the engine coolant temperature was below 160°F, and driving the vehicle on a predetermined test loop that had a variety of driving speeds and conditions. A diagnostic scan tool was used to monitor the short-term fuel trim values to ensure that they varied no more $\pm 3\%$, which is an acceptable range for emission testing.

3.3 Wide-Open-Throttle Full-Load Horsepower Testing

The vehicle emission testing drive cycle is a relatively light-load, low-speed test used to simulate normal driving. The test does not simulate all driving conditions or environmental conditions. As a vehicle is driven at higher speeds, is carrying a heavy load or pulling a trailer, or operating in an extremely cold temperature, it will require more fuel to be delivered by the fuel injectors. As ethanol blends increase, a point may be reached where the injectors do not have the flow capacity required for proper operation. This point cannot be simulated on the emission/fuel economy test.

Therefore, prior to any emission/fuel economy testing, each vehicle was placed on a Mustang computer-controlled chassis dynamometer (Figure 5) to run the vehicle at peak horsepower for an extended period of time. This required the vehicle to demand the maximum amount of fuel it would need under high-load conditions. If the ECU detected a lean mixture that it was unable to adjust for, the malfunction indication light (MIL) would become illuminated on the dash, indicating a fault code.

Each time a new fuel blend was placed in a vehicle, this testing was conducted. If the MIL came on and a lean AFR condition was indicated, no emission or fuel economy testing was conducted on that blend level.



Figure 5. Mustang chassis dynamometer.

3.4 Fuel Economy and Emission Testing

The fuel economy and emission testing was performed by the Minnesota Center for Automotive Research (MnCAR) at the University of Minnesota Mankato branch. The system used in the MnCAR lab to measure vehicle tailpipe emissions is a California Analytical Instruments dilution system, which includes five specific systems: the SuperFlow AC motor-driven chassis dynamometer, the critical flow venturi, the drive cycle and driver's trace monitor, the FTP-75 driving cycle and the HWFET driving cycle, and the gas analyzers.

3.5 SuperFlow AC Motor-Driven Chassis Dynamometer

The SuperFlow AC motor-driven chassis dynamometer (Figure 6) allows a vehicle to operate as though being driven on the highway. The inertia weight and horsepower loads are varied by the dynamometer to replicate the loads the vehicle would experience on the road under acceleration and deceleration conditions. This allows the dynamometer to simulate real-world driving conditions with excellent repeatability. This dynamometer is capable of simulating the mass and power requirements of a vehicle under transient operating conditions. The mass of the vehicle and its power requirements are entered into the control software. Once these values are entered, the dynamometer can provide a simulated load that is exactly the same as the vehicle would encounter on the road. This allows the elimination of variables normally encountered on the road, including wind, rain, temperature, traffic, and other variables that affect vehicle operation.



Figure 6. SuperFlow AC motor-driven chassis dynamometer.

3.6 Critical Flow Venturi

The second component of the system is the critical flow venturi, which accurately dilutes the exhaust sample before it reaches the gas analyzers. Either a 350-scfm or a 700-scfm critical flow venturi can be used in the system depending on the emission concentrations of the sample vehicle. The 350-scfm venturi was used because the emission is diluted with less air, improving testing accuracy. A transfer hose was connected to the tailpipe to collect the exhaust gases and direct them into the analyzer cabinet that contains the critical flow venturi.

3.7 Drive Cycle and Driver's Trace Monitor

The third system utilized is the drive cycle and driver's trace monitor. Once the vehicle is properly mounted with the sampling system in place and all the controls and instrumentation are set, the vehicle is driven following a specific drive cycle on a computer monitor. A drive cycle is a speed-versus-time trace designed to simulate a specific type of driving condition. To do this, the driver starts the engine and attempts to follow the driving cycle shown on a computer monitor by accelerating and braking the vehicle. If the vehicle speed deviates from the trace, the test is aborted and must be repeated. The two test procedures that were used to test the four vehicles are the FTP-75 and the HWFET.

3.8 FTP-75 Driving Cycle

The FTP-75 is the standard federal exhaust emission driving cycle, which uses the urban dynamometer driving schedule (UDDS). The FTP-75 cycle is used by all automobile

manufacturers and EPA for emission certification of light-duty vehicles. This cycle has three separate phases: a cold-start (505-second) phase known as Bag 1, a hot-transient (864-second) phase known as Bag 2, and a hot-start (505-second) phase known as Bag 3. The hot-start 505 is often called the Hot-505. The three test phases are referred to as Bag 1, Bag 2, and Bag 3 because exhaust samples are collected in separate Tedlar bags during each phase. During a 10-minute cooldown between the second and third phase, the engine is turned off. The 505-second driving trace for the first and third phase is identical. The total test time for the 11-mile FTP-75 is 1874 seconds (31.23 minutes), the top speed is 56.7 mph, and the average speed is 21.4 mph (Figure 7). A single test was performed for each vehicle on both Tier 2 and the optimal ethanol blend level.

3.9 HWFET Driving Cycle

The HWFET cycle (Figure 8) is a chassis dynamometer driving cycle developed by EPA for the determination of fuel economy of light-duty vehicles. This cycle simulates highway driving at varying speeds, with no stopping until the end of the test. This drive cycle was used to determine the fuel economy for the four vehicles tested. Emission data were obtained, although they are not utilized by the EPA vehicle certification protocol. Each test was performed in triplicate.

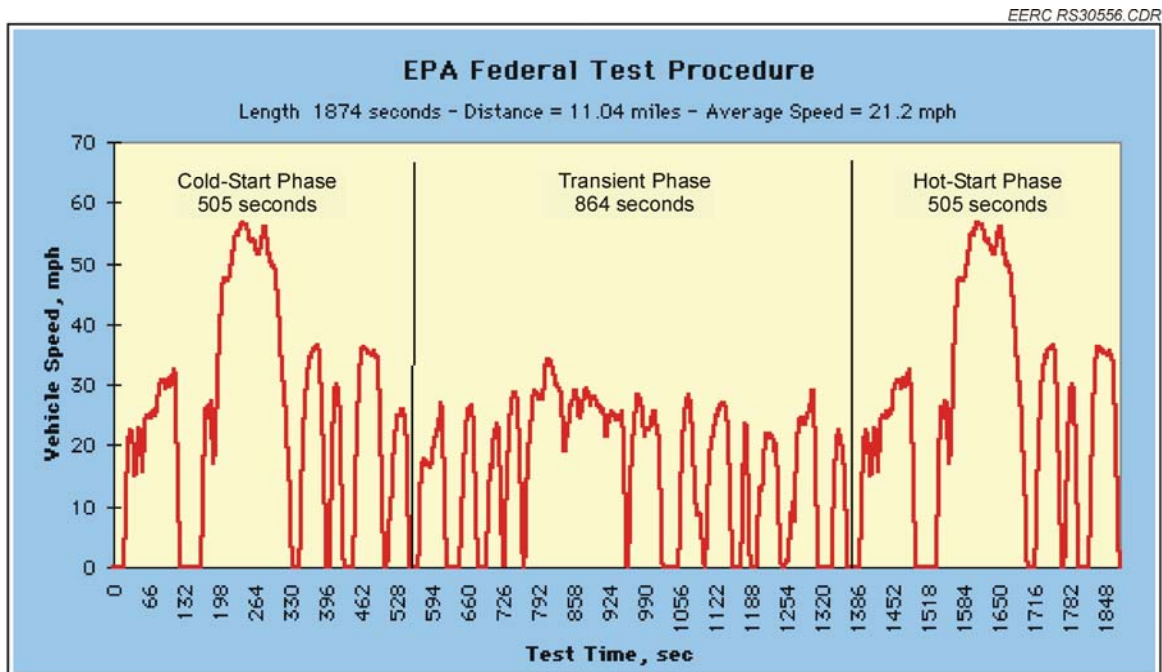

Figure 7. FTP-75.

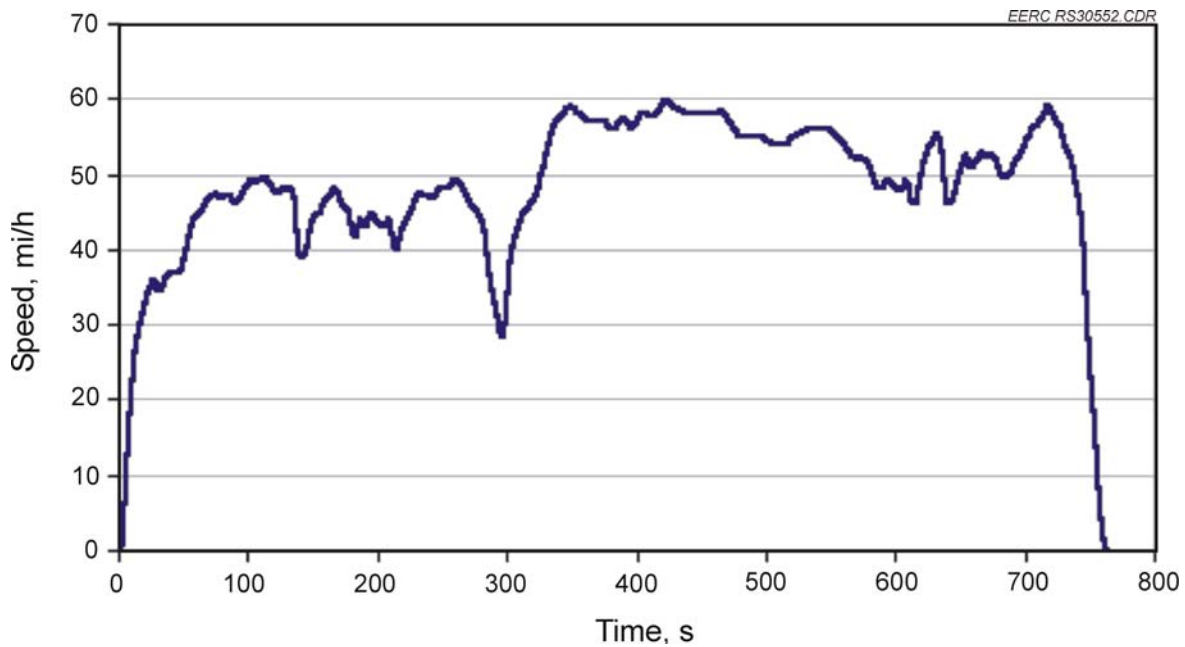

Figure 8. HWFET.

4.0 GAS ANALYZERS

The fourth part of the system is the exhaust gas analyzers. The analyzers used in the project measured the following gases: hydrocarbons, oxides of nitrogen, carbon monoxide, and carbon dioxide. Before the tests were run, each analyzer was calibrated using EPA procedures. The specific details of each analyzer are explained below.

4.1 Hydrocarbons

Hydrocarbon emissions result from fuel that does not burn completely in the engine. Some of the hydrocarbons can react with NO_x and sunlight to form ozone, a major component of smog. Ozone is beneficial in the upper atmosphere, where it protects the earth by filtering out ultraviolet radiation, but at ground level, it is a noxious pollutant. Ozone irritates the lung tissue and causes coughing, choking, and stinging eyes. Some hydrocarbons emitted in exhaust, such as benzene, are known carcinogens, and others, such as 1,3-butadiene, are suspected carcinogens. Hydrocarbons are detected using a flame ionization detector (FID), discussed in Appendix A (shown in Figure A-1).

4.2 Carbon Monoxide and Carbon Dioxide

Carbon monoxide (CO), which is colorless, odorless, and poisonous, is a product of incomplete combustion. CO is dangerous to humans because it reduces the flow of oxygen in the bloodstream. Infants, the elderly, and persons with respiratory problems are particularly sensitive. Carbon dioxide (CO_2) is the product of complete combustion. CO and CO_2 are analyzed using a nondispersive infrared detector (NDIR) (Figure A-2).

4.3 Oxides of Nitrogen (NO_x)

Nitrogen and oxygen atoms react during combustion to form various oxides of nitrogen. NO_x leads to the formation of ozone and contributes to the formation of acid rain. NO_x is determined using a chemiluminescence detector (Figure A-3).

5.0 FUEL ECONOMY TEST RESULTS

5.1 Calculated Fuel Economy

For each vehicle, fuel economy values were calculated for each ethanol blend based on:

- Measured fuel economy with Tier 2 fuel.
- A Tier 2 gasoline lower heating value (LHV) of 114,187 Btu/gallon.
- An ethanol LHV of 76,000 Btu/gallon.
- The proportion of Tier 2 gasoline and ethanol in each fuel blend.

For example, measured fuel economy for the Ford Fusion on Tier 2 gasoline is 23.48 mpg. The E30 calculated fuel economy is determined using the formula below:

$$\begin{aligned}\text{Calculated fuel economy} &= ([\text{gasoline fraction}][\text{gasoline LHV}] + [\text{ethanol fraction}][\text{ethanol LHV}])(\text{measured mpg})/\text{gasoline LHV} \\ &= ([0.7][114,187 \text{ Btu/gal}] + [0.3][76,000 \text{ Btu/gal}]) (23.48 \text{ mpg})/114,187 \text{ Btu/gal} \\ &= 21.21 \text{ mpg}\end{aligned}$$

The calculated fuel economy values for all of the vehicles are shown in the graph in Figure 9.

When the measured and calculated fuel economy values for a vehicle are superimposed graphically, fuel economy performance can be easily visualized and evaluated. If the measured fuel economy was above the calculated fuel economy line, the vehicle performed better than expected, if below, poorer than expected. The fuel economy performance of each vehicle was evaluated based on these data. The measured fuel economy is the average of three replicate tests. An error bar, encompassing the variance of the results, is included in each fuel economy graph.

5.2 Toyota Camry Fuel Economy

The Toyota Camry gave an engine fault code on E70 but ran well on E65. The Camry operated very close to the calculated fuel economy throughout the range of the tested fuels. HWFET fuel economy values for the eight tested blends were below calculated for all blends except E30. There is a definite peak at E30, which indicates an optimum blend level for this vehicle, shown in Figure 10.

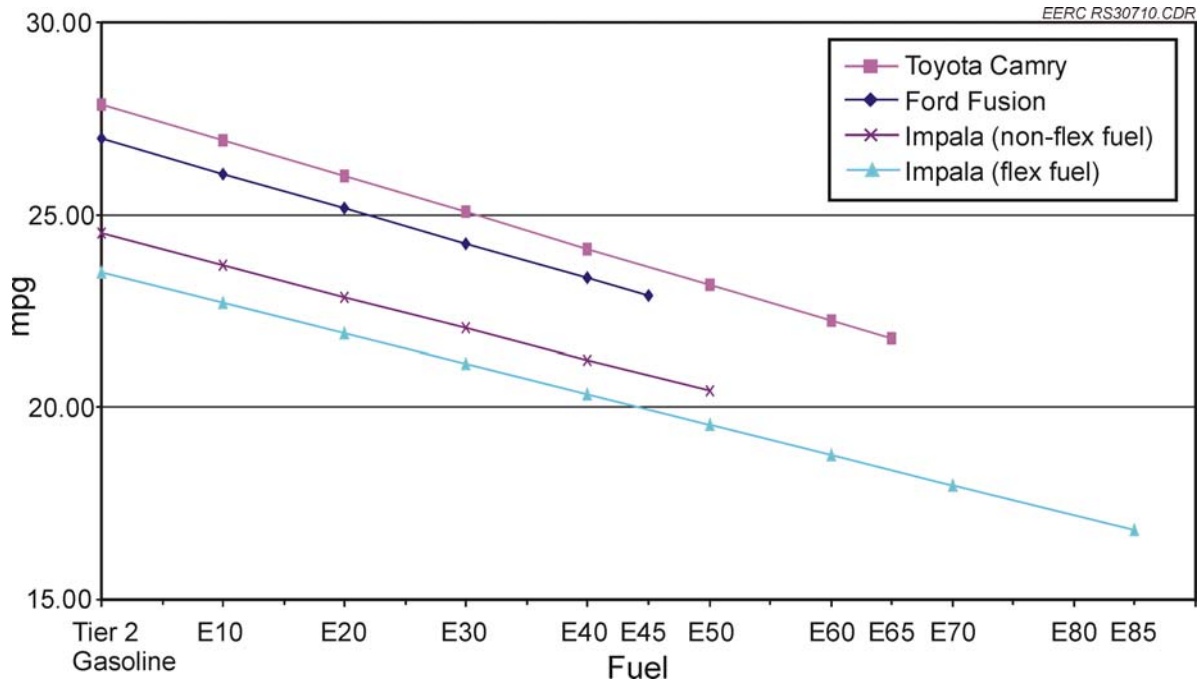

Figure 9. Calculated highway fuel economy.

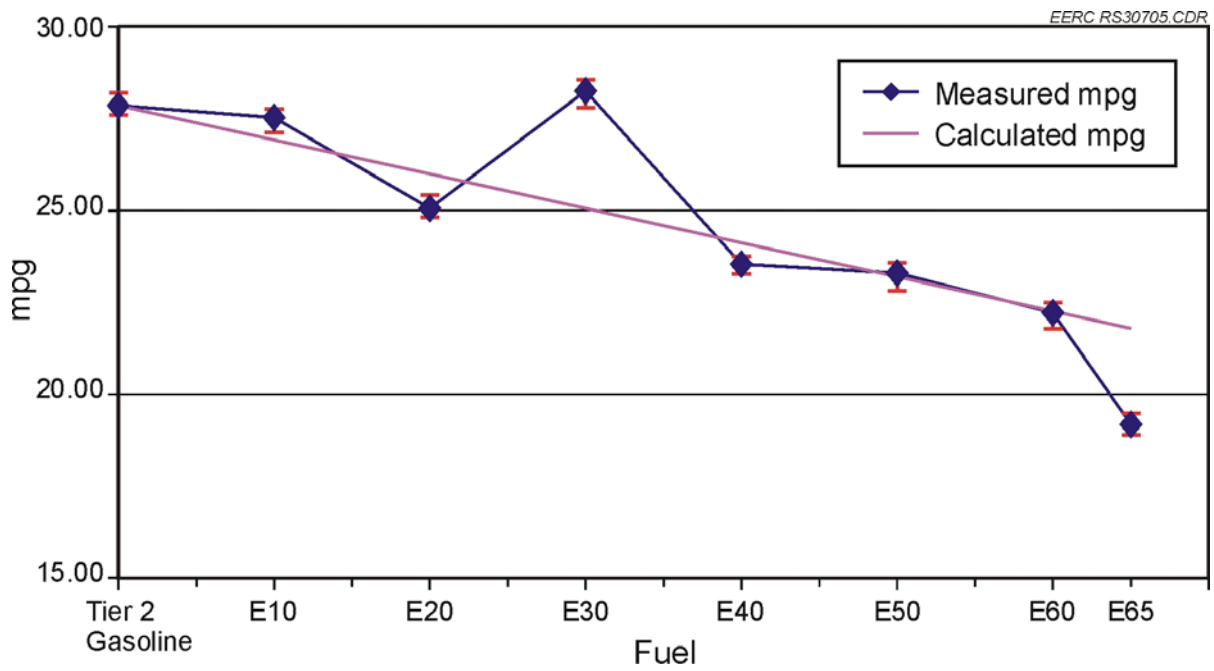

Figure 10. 2007 Toyota Camry, 2.4-L engine, highway fuel economy.

5.3 Chevrolet Impala (non-flex fuel) Fuel Economy

The Chevrolet Impala (non-flex fuel) gave an engine fault code on E70, but ran well on E55. The Impala operated very close to the calculated fuel economy throughout the range of the tested fuels. HWFET fuel economy values for the eight tested blends were very close to calculated values for all blends except E40. There is a definite peak at E40, which indicates an optimum blend level for this vehicle, shown in Figure 11.

5.4 Chevrolet Impala (flex fuel) Fuel Economy

The flex-fuel Chevrolet Impala ran well on all ethanol blend levels. HWFET fuel economy values for the nine tested blends were above calculated values for all blends tested. There is a definite peak at E20, which indicates an optimum blend level for this vehicle, shown in Figure 12.

5.5 Ford Fusion Fuel Economy

The Ford Fusion gave an engine fault code on E50, but ran well on E45. HWFET fuel economy values for the six tested blends were below calculated values for all blends except E30. There is a definite peak at E30, which indicates an optimum blend level for this vehicle, shown in Figure 13.

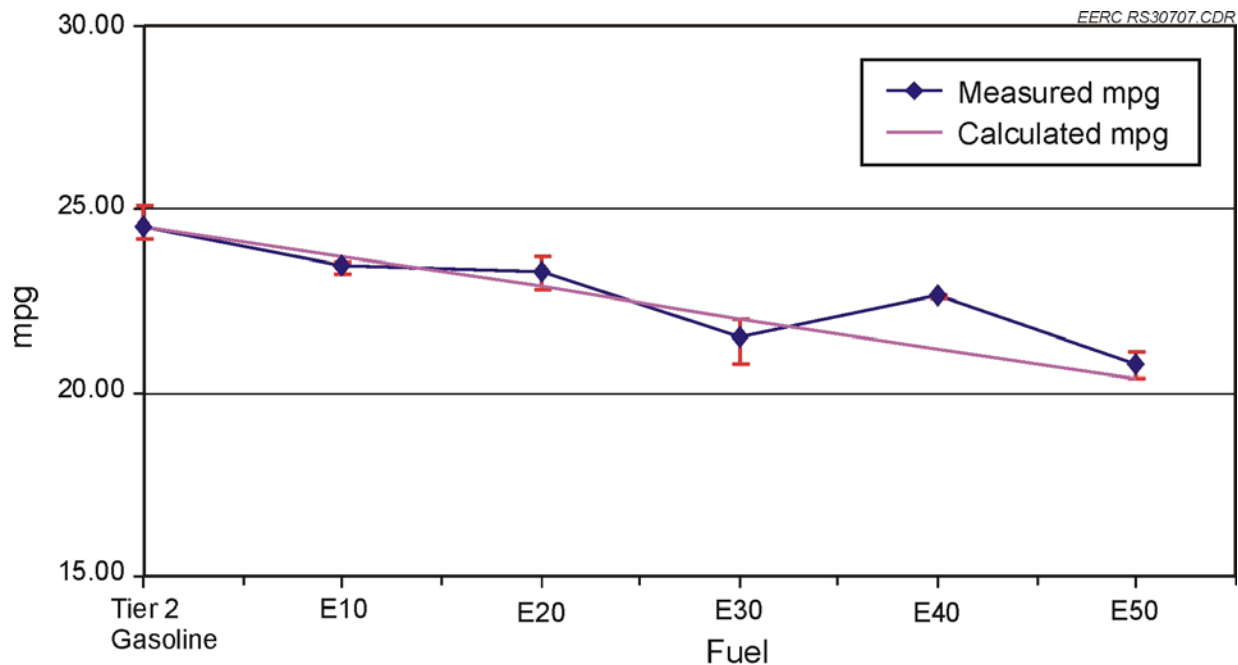

Figure 11. 2007 Chevrolet Impala (non-flex fuel), 3.5-L engine, highway fuel economy.

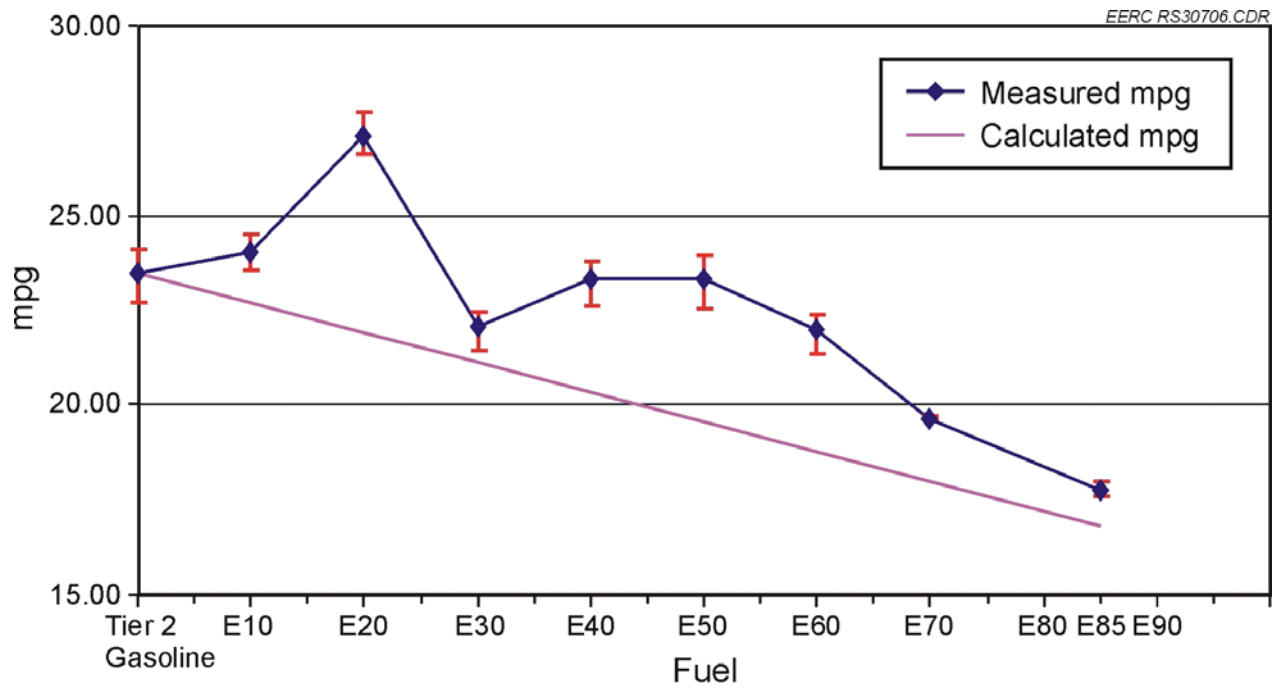

Figure 12. 2007 Chevrolet Impala (flex fuel), 3.5-L engines highway fuel economy.

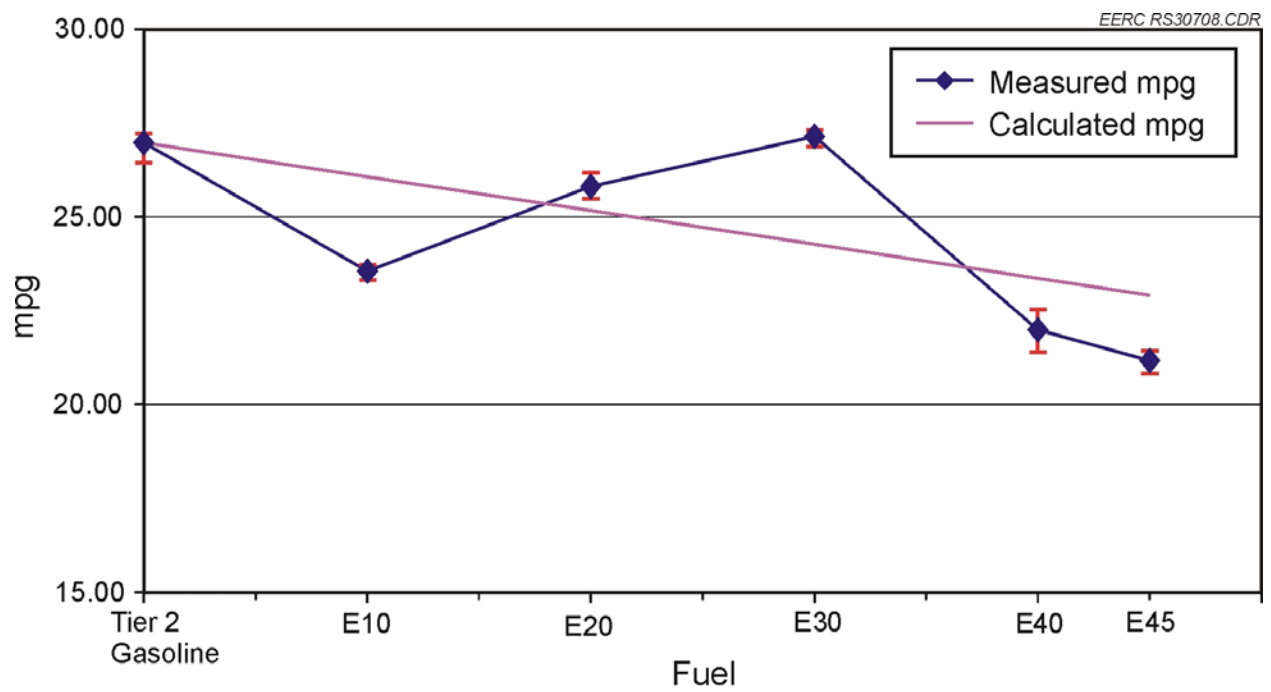

Figure 13. 2007 Ford Fusion, 2.3-L engine, highway fuel economy.

5.6 Fuel Economy Improved

EPA requires all automobile manufacturers that sell light-duty vehicles in the United States to provide vehicle exhaust emissions and city fuel economy values, as determined by the EPA FTP-75 driving cycle test. The vehicle exhaust emissions must meet or be less than Tier 2 light-duty exhaust emission standards. In addition, the vehicle highway fuel economy must be determined by the EPA HWFET. The four vehicles tested in this investigation were subjected to the EPA protocol related to FTP-75 and HWFET. It is notable that the Ford Fusion and Toyota Camry obtained a HWTET mileage on E30 of 1% greater than on Tier 2 gasoline, and the flex-fuel Chevrolet Impala showed a HWFET mileage of 15% on E20 better than Tier 2 gasoline, as shown in Figure 14.

6.0 EMISSION TEST RESULTS: FTP-75 AND HWFET EMISSIONS

Current exhaust catalytic converter technology is very advanced. Catalytic converters are easily able to control emissions below the EPA-mandated Tier 2 Light-Duty Full-Useful-Life Exhaust Emissions Standards Bin 5 values (Figure A-5) when the catalyst is at design operating temperature. All 2004 models and later vehicles sold in the United States must meet, at a minimum, Tier 2 Bin 5 criteria, as shown in Table 4. The lower the bin number is, the cleaner the vehicle burns fuel:

Tier 2 Bin 1: the cleanest federal Tier 2 standard, a zero-emission vehicle (ZEV)

Tier 2 Bins 2 through 4: cleaner than the average standard

Tier 2 Bin 5: “average” of new Tier 2 standards

Nonmethane organic gas (NMOG) values were not obtained directly. Total hydrocarbon (THC) data from the FTP-75 and HWFET testing were converted to NMOG values using the following formula (2):

$$\text{NMOG} = (\text{THC})(0.84)$$

HWFET conditions ensure that the catalyst is at design operating temperature, which results in favorable emission results. FTP-75 tests the vehicle exhaust emissions from a cold start and during warmup, at which time exhaust emissions are at their highest concentration. All four vehicles tested had both HWFET and FTP-75 CO, NO_x, and NMOG emissions levels, as shown in Tables 5–8, below Tier 2 Bin 5 values at all ethanol blend levels, with the exception of the flex-fuel Chevrolet Impala. The flex-fuel Chevrolet Impala exceeded the NMOG standard on the FTP-75 for both E20 (0.120 grams/mile) and Tier 2 fuels (0.152 grams/mile) (Tables 4–7). Raw data for these tests are shown in Figure A-6.

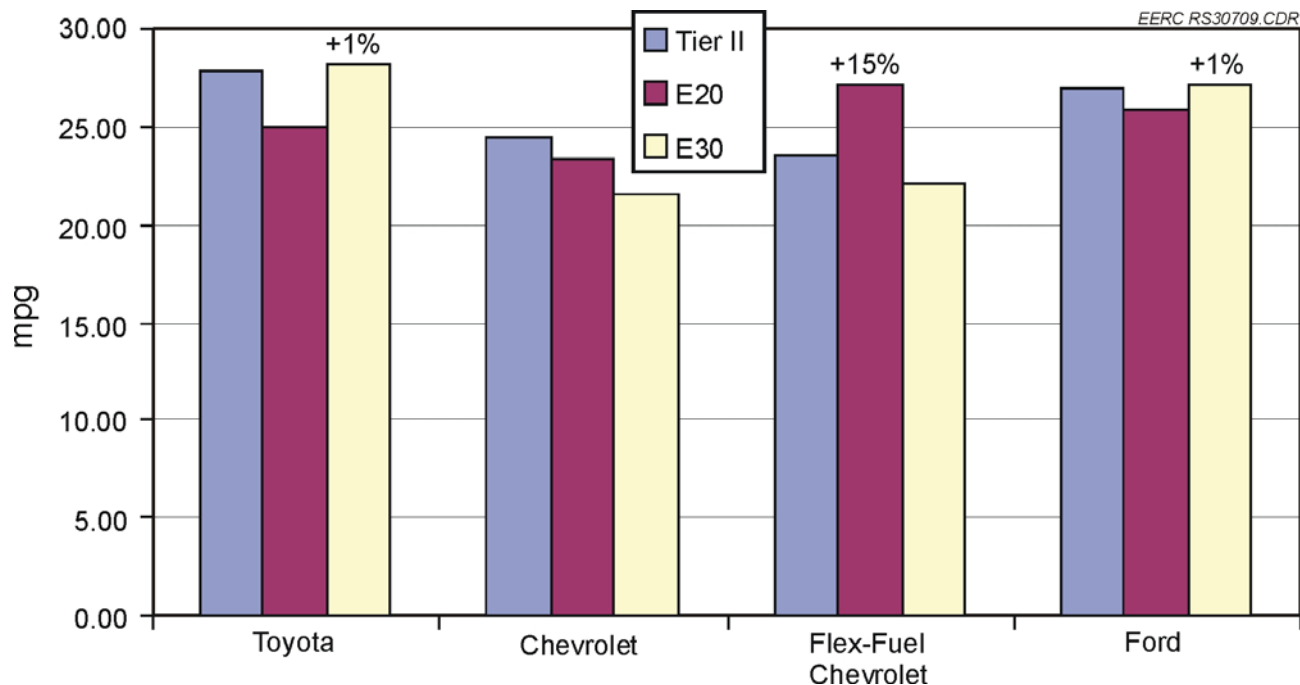

Figure 14. Highway fuel economy improvement, E20 and E30 vs. Tier 2 gasoline.

Table 4. Tier 2 Light-Duty, Full-Useful-Life Exhaust Emission Standards, grams/mile

Bin Number	NO _x	NMOG	CO	HCHO (formaldehyde)	PM (particulate matter)
5	0.07	0.090	4.2	0.018	0.01

7.0 DISCUSSION AND CONCLUSIONS

The EERC and MnCAR conducted vehicle fuel economy and emission testing on four 2007 model vehicles. The vehicles tested included a flex-fuel Chevrolet Impala and three non-flex-fuel vehicles: a Ford Fusion, a Toyota Camry, and a Chevrolet Impala. This investigation utilized a range of ethanol blend levels from 0% to 85% in 10% increments. The primary objective of the investigation was to investigate the possible existence of a fuel economy-based optimal ethanol blend level, as determined by the HWFET, at which measured miles per gallon is greater than predicted based strictly on per-gallon fuel Btu content. A secondary objective was to acquire HWFET hot-start tailpipe emission data for all surveyed fuels. Following optimal blend level determination, cold-start emissions, as determined by FTP-75, were determined on the optimal blend level and Tier 2 gasoline.

HWFET testing on ethanol blend levels of E20 in the flex-fuel Chevrolet Impala, E30 in the non-flex-fuel Ford Fusion and Toyota Camry, and E40 in the non-flex-fuel Chevrolet Impala resulted in miles-per-gallon fuel economy greater than predicted based on per-gallon fuel Btu

Table 5. FTP-75 and HWFET Emissions and Fuel Economy for Toyota Camry, grams/mile

Fuel		THC	NMOG*	CO	NO _x	CO ₂	mpg
Tier 2		NA**	0.090	4.2	0.07	NA	NA
Bin 5	Test	NA**	0.090	4.2	0.07	NA	NA
E30	FTP-75	0.037	0.035	0.1	0.000	426	18.59
Tier 2	FTP-75	0.020	0.019	0.8	0.04	446	19.81
Tier 2	HWFET	0.002	0.002	0.2	0.03	318	27.85
E10	HWFET	0.003	0.003	0.2	0.02	311	27.53
E20	HWFET	0.014	0.014	0.2	0.03	329	25.05
E30	HWFET	0.009	0.008	0.3	0.02	280	28.25
E40	HWFET	0.007	0.006	0.2	0.02	323	23.54
E50	HWFET	0.007	0.006	0.4	0.03	313	23.30
E60	HWFET	0.013	0.013	0.4	0.04	314	22.21
E65	HWFET	0.016	0.015	0.7	0.04	355	19.18

* THC × 0.84.

** Not applicable.

Table 6. FTP-75 and HWFET Emissions and Fuel Economy for Chevrolet Impala (non-flex fuel), grams/mile

Fuel		THC	NMOG*	CO	NO _x	CO ₂	mpg
Tier 2		NA	0.090	4.2	0.07	NA	NA
Bin 5	Test	NA	0.090	4.2	0.07	NA	NA
E40	FTP-75	0.046	0.043	2.4	0.07	490	15.42
Tier 2	FTP-75	0.092	0.087	2.4	0.05	544	16.19
Tier 2	HWFET	0.088	0.083	1.3	0.02	360	24.51
E10	HWFET	0.069	0.065	1.2	0.01	363	23.44
E20	HWFET	0.076	0.072	1.1	0.03	351	23.30
E30	HWFET	0.074	0.070	1.3	0.00	366	21.53
E40	HWFET	0.057	0.054	1.0	0.02	334	22.65
E50	HWFET	0.031	0.029	0.4	0.01	351	20.80

* THC × 0.84.

Table 7. FTP-75 and HWFET Emissions and Fuel Economy for Chevrolet Impala (flex fuel), grams/mile

Fuel		THC	NMOG*	CO	NO _x	CO ₂	mpg
Bin 5	Test	NA	0.090	4.2	0.07	NA	NA
E20	FTP-75	0.127	0.120	2.1	0.00	491	16.65
Tier 2	FTP-75	0.161	0.152	1.9	0.01	604	14.61
Tier 2	HWFET	0.068	0.064	0.9	0.02	376	23.48
E10	HWFET	0.069	0.065	0.8	0.01	355	24.02
E20	HWFET	0.057	0.054	0.7	0.01	303	27.07
E30	HWFET	0.035	0.033	0.7	0.02	359	21.85
E40	HWFET	0.025	0.024	0.6	0.00	326	22.81
E50	HWFET	0.030	0.029	0.6	0.02	313	23.32
E60	HWFET	0.034	0.032	0.5	0.01	317	22.00
E70	HWFET	0.034	0.032	0.5	0.01	339	19.67
E85	HWFET	0.023	0.022	0.6	0.04	349	17.74

* THC × 0.84.

Table 8. FTP-75 and HWFET Emissions and Fuel Economy for Ford Fusion, grams/mile

Fuel		THC	NMOG*	CO	NO _x	CO ₂	mpg
Bin 5	Test	NA	0.090	4.2	0.07	NA	NA
E30	FTP-75	0.013	0.012	0.7	0.01	435	18.19
Tier 2	FTP-75	0.008	0.008	0.9	0.01	445	19.81
Tier 2	HWFET	0.004	0.003	0.2	0.00	329	26.97
E10	HWFET	0.000	0.000	0.5	0.01	363	23.55
E20	HWFET	0.002	0.002	0.4	0.00	319	25.81
E30	HWFET	0.006	0.006	0.2	0.00	292	27.14
E40	HWFET	0.001	0.001	0.5	0.01	346	21.99
E45	HWFET	0.002	0.002	0.5	0.00	352	21.16

* THC × 0.84.

content. It is notable that the non-flex-fuel vehicles obtained greater fuel economy at higher blends of ethanol than they were designed for. In the case of the flex-fuel Chevrolet Impala, the highway fuel economy was greater than calculated for all tested blends, with an especially high peak at E20. While only three non-flex-fuel vehicles were tested in this study, there is a strong indication that non-flex-fuel vehicles operated on optimal ethanol blend levels, which are higher than the standard E10 blend, can obtain better fuel mileage than predicted by fuel energy content.

Exhaust emission values for NMOG, CO, and NO_x obtained from both the FTP-75 and the HWFET driving cycles were at or below EPA Tier 2, light-duty vehicle, Bin 5 levels of 0.090, 0.07, and 4.2 grams/mile, respectively, for all vehicles tested with one exception. The flex-fuel Chevrolet Impala exceeded the NMOG standard for the FTP-75 on E20 and Tier 2 gasoline at 0.120 grams/mile and 0.152 grams/mile, respectively. Formaldehyde and PM values were not obtained during these tests.

8.0 REFERENCES

1. U.S. Environmental Protection Agency. Part II, 40 CFP Parts 80, 85, and 86, Control of Air Pollution from New Motor Vehicles: Tier 2 Motor Vehicle Emissions Standards and Gasoline Sulfur Control Requirements; Final Rule; 2000.
2. U.S. Environmental Protection Agency. 2006 Model Light Duty Gasoline Vehicle, Fuel Economy Test Results, personal communication, Robert Frend, EPA Office of Transportation and Air Quality, Assessment and Standards Division.

APPENDIX A

ANALYZER SCHEMATICS AND TIER 2 EMISSION STANDARDS

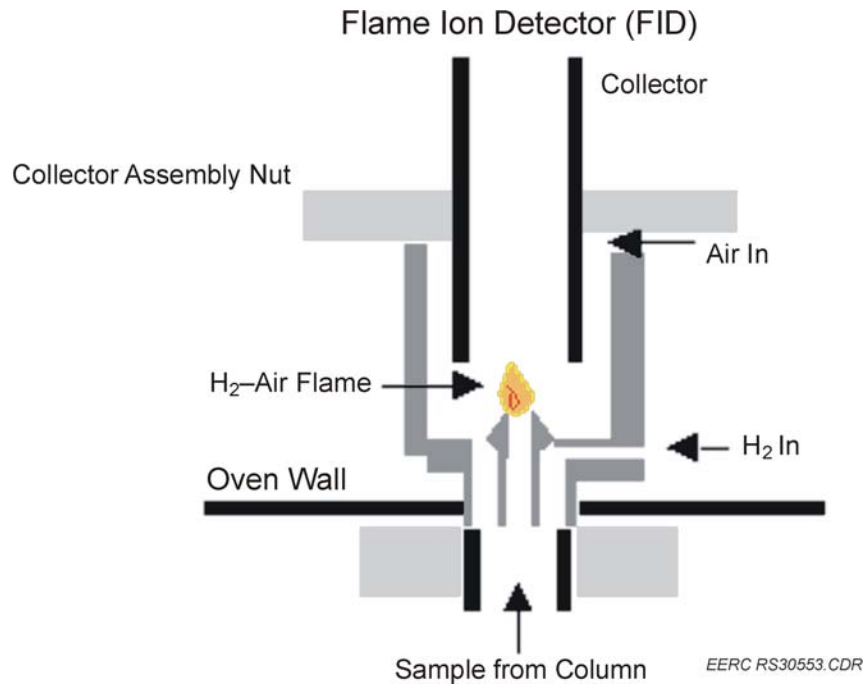

Figure A-1. Flame ionization detector.

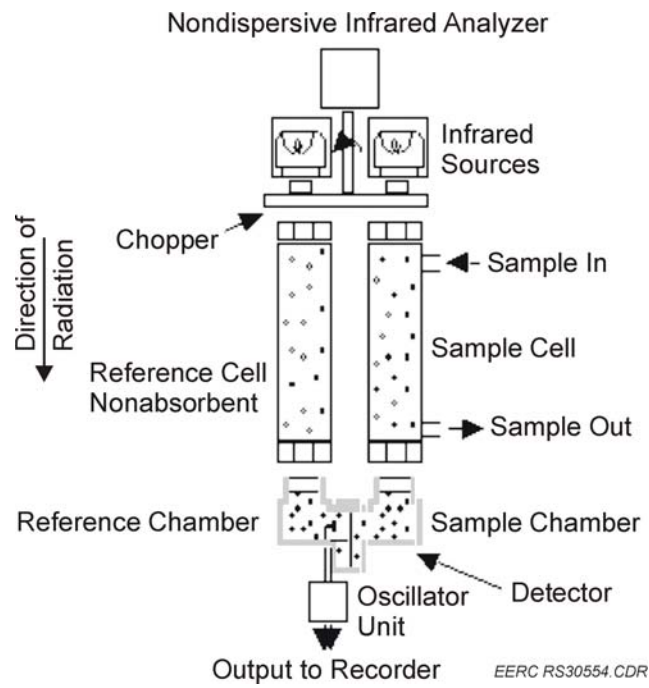

Figure A-2. Infrared analyzer.

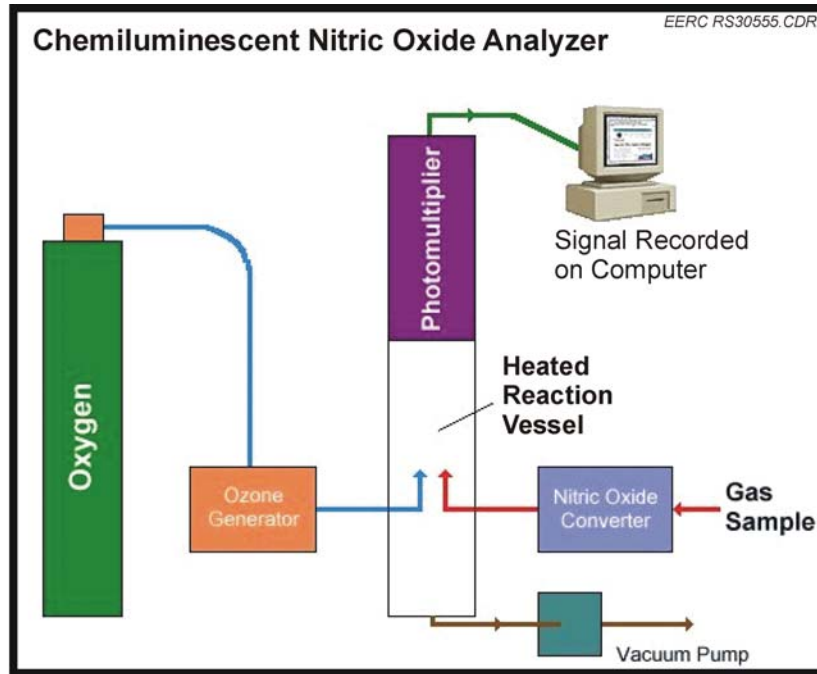

Figure A-3. NO_x analyzer.

Table A-1. Tier 2 Light-Duty Full-Useful-Life Exhaust Emission Standards, grams per mile

Bin No.	NO _x	NMOG	CO	HCHO	PM	Notes
10	0.6	0.156/0.230	4.2/6.4	0.018/0.027	0.08	a, b, c, d
9	0.3	0.090/0.180	4.2	0.018	0.06	a, b, e
The above temporary bins expire in 2006 (for LDVs and LLDTs) and 2008 (for HLDTs)						
8	0.20	0.125/0.156	4.2	0.018	0.02	b, f
7	0.15	0.090	4.2	0.018	0.02	
6	0.10	0.090	4.2	0.018	0.01	
5	0.07	0.090	4.2	0.018	0.01	
4	0.04	0.070	2.1	0.011	0.01	
3	0.03	0.055	2.1	0.011	0.01	
2	0.02	0.010	2.1	0.004	0.01	
1	0.00	0.000	0.0	0.000	0.00	

Notes:

^a Bin deleted at end of 2006 model year (2008 for HLDTs).

^b The higher temporary NMOG, CO, and HCHO values apply only to HLDTs and expire after 2008.

^c An additional temporary higher bin restricted to MDPVs is discussed in Section IV.B.4.g.

^d Optional temporary NMOG standard of 0.280 grams/mi applies for qualifying LDT4s and MDPVs only.

^e Optional temporary NMOG standard of 0.130 grams/mi applies for qualifying LDT2s only. See report.

^f Higher temporary NMOG standard is deleted at end of 2008 model year.

Table A-2. Toyota Non-Flex-Fuel Emission and Fuel Economy Raw Data

Year	2007	Color:	black							
Make	Toyota									
Model	Camry									
Engine Family	7TYXV02.4BEB	2.4 liter motor								
Evap Family	7TYXR0130A12									
Test Weight	3750									
HP@50	11.4									
					NMOG = THC x 0.84					
Tier 2 Bin 5 Emissions Standards, grams/mile					0.090	4.2	0.07			
Fuel	Test Number	Test Name	Remarks	THC	NMOG	CO	NO _x	CO ₂	Fuel Economy	
Optimal	MSU	FTP 75	Optimal E30	0.037	0.031	0.1	0.00	426	18.59	
Tier 2	MSU 1804	FTP 75	Tier 2	0.020	0.017	0.8	0.04	446	19.81	
Tier 2		HWFET	Tier 2 Test 1	0.005	0.004	0.2	0.06	322	27.50	
		HWFET	Tier 2 Test 2	0.000	0.000	0.2	0.00	315	28.10	
		HWFET	Tier 2 Test 3	0.000	0.000	0.2	0.03	317	27.95	
			AVERAGE	0.002	0.002	0.2	0.03	318	27.85	
E-10	MSU1741	HWFET	E-10 Test 1	0.007	0.006	0.2	0.04	313	27.33	
	MSU1742	HWFET	E-10 Test 2	0.002	0.002	0.2	0.01	306	27.95	
	MSU1743	HWFET	E-10 Test 3	0.001	0.001	0.2	0.02	314	27.31	
			AVERAGE	0.003	0.003	0.2	0.02	311	27.53	
E-20	MSU1732	HWFET	E-20 Test 1	0.015	0.013	0.2	0.01	334	24.68	
	MSU1733	HWFET	E-20 Test 2	0.017	0.014	0.2	0.07	326	25.28	
	MSU1735	HWFET	E-20 Test 3	0.011	0.009	0.2	0.00	327	25.18	
			AVERAGE	0.014	0.012	0.2	0.03	329	25.05	
E-30	MSU1714	HWFET	E-30 Test 1	0.010	0.008	0.4	0.02	282	28.11	
	MSU1715	HWFET	E-30 Test 2	0.007	0.006	0.2	0.01	276	28.7	
	MSU1716	HWFET	E-30 Test 3	0.010	0.008	0.3	0.04	283	27.94	
			AVERAGE	0.009	0.008	0.3	0.02	280	28.25	
E-40	MSU1702	HWFET	E-40 Test 1	0.010	0.008	0.2	0.01	324	23.48	
	MSU1703	HWFET	E-40 Test 2	0.008	0.007	0.1	0.03	320	23.81	
	MSU1705	HWFET	E-40 Test 3	0.002	0.002	0.1	0.00	326	23.33	
			AVERAGE	0.007	0.006	0.2	0.02	323	23.54	
E-50	MSU1683	HWFET	E-50 Test 1	0.007	0.006	0.4	0.04	316	23.1	
	MSU1684	HWFET	E-50 Test 2	0.007	0.006	0.3	0.01	307	23.79	
	MSU1685	HWFET	E-50 Test 3	0.006	0.005	0.4	0.03	317	23.02	
			AVERAGE	0.007	0.006	0.4	0.03	313	23.30	
E-60	MSU1602	HWFET	E-60 Test 2	0.024	0.020	0.4	0.04	316	22.09	
	MSU1603	HWFET	E-60 Test 3	0.016	0.013	0.4	0.04	318	21.92	
	MSU1604	HWFET	E-60 Test 4	0.000	0.000	0.3	0.04	309	22.63	
			AVERAGE	0.013	0.011	0.4	0.04	314	22.21	
E-65	MSU1602	HWFET	E-65 Test 1	0.007	0.006	0.6	0.03	350	19.47	
	MSU1603	HWFET	E-65 Test 2	0.024	0.020	0.9	0.05	361	18.88	
	MSU1604	HWFET	E-65 Test 3	0.016	0.013	0.7	0.05	355	19.19	
			AVERAGE	0.016	0.013	0.7	0.04	355	19.18	

Table A-3. Chevrolet Flex-Fuel Emission and Fuel Economy Raw Data

2007	Color: white
Chevy	
Impala	flex
7GMXV03.5052	3.5 liter motor
7GMR0133810	
3875	
11.5	

NMOG = THC x 0.84

Tier 2 Bin 5 Emissions Standards, grams/mile				0.090	4.2	0.07			
Fuel	Test Number	Test Name	Remarks	THC	NMOG	CO	NO _x	CO ₂	Fuel Economy
Optimal	MSU	FTP 75	Optimal E20	0.127	0.107	2.1	0.00	491	16.65
Tier 2	MSU1745	FTP 75	Tier 2	0.161	0.135	1.9	0.01	604	14.61
Tier 2	MSU1746	HWFET	Tier 2 Test 1	0.069	0.058	1.0	0.03	387	22.82
	MSU1747	HWFET	Tier 2 Test 2	0.061	0.051	0.9	0.00	378	23.35
	MSU1752	HWFET	Tier 2 Test 3	0.075	0.063	0.9	0.03	364	24.26
			AVERAGE	0.068	0.057	0.9	0.02	376	23.48
E-10	MSU1736	HWFET	E-10 Test 1	0.081	0.068	0.7	0.02	355	24.05
	MSU1737	HWFET	E-10 Test 2	0.061	0.051	0.8	0.01	363	23.50
	MSU1738	HWFET	E-10 Test 3	0.064	0.054	0.8	0.00	348	24.51
			AVERAGE	0.069	0.058	0.8	0.01	355	24.02
E-20	MSU1721	HWFET	E-20 Test 1	0.076	0.064	0.7	0.00	302	27.22
	MSU1723	HWFET	E-20 Test 3	0.046	0.039	0.6	0.00	298	27.55
	MSU1724	HWFET	E-20 Test 4	0.050	0.042	0.7	0.03	311	26.44
			AVERAGE	0.057	0.048	0.7	0.01	303	27.07
E-30	MSU1709	HWFET	E-30 Test 1	0.036	0.030	0.8	0.03	365	21.63
	MSU1710	HWFET	E-30 Test 2	0.033	0.028	0.7	0.00	350	22.61
	MSU1711	HWFET	E-30 Test 3	0.036	0.030	0.6	0.01	362	21.85
			AVERAGE	0.035	0.029	0.7	0.02	359	22.03
E-40	MSU1693	HWFET	E-40 Test 1	0.024	0.020	0.5	0.00	328	23.14
	MSU1695	HWFET	E-40 Test 2	0.017	0.014	0.5	0.00	318	23.93
	MSU1697	HWFET	E-40 Test 4	0.035	0.029	0.7	0.00	333	22.81
			AVERAGE	0.025	0.021	0.6	0.00	326	23.29
E-50	MSU1680	HWFET	E-50 Test 2	0.028	0.024	0.6	0.02	321	22.68
	MSU1681	HWFET	E-50 Test 3	0.028	0.024	0.6	0.02	315	23.15
	MSU1581	HWFET	E-50 Test 4	0.035	0.029	0.6	0.02	302	24.12
			AVERAGE	0.030	0.025	0.6	0.02	313	23.32
E-60	MSU1667	HWFET	E-60 Test 1	0.042	0.035	0.4	0.01	320	21.80
	MSU1668	HWFET	E-60 Test 2	0.022	0.018	0.4	0.00	309	22.61
	MUS1670	HWFET	E-60 Test 3	0.038	0.032	0.6	0.04	323	21.58
			AVERAGE	0.034	0.029	0.5	0.01	317	22.00
E-70	MSU1649	HWFET	E-70 Test 1	0.037	0.031	0.6	0.00	340	19.60
	MSU1650	HWFET	E-70 Test 2	0.039	0.033	0.5	0.02	338	19.69
	MSU1651	HWFET	E-70 Test 3	0.025	0.021	0.5	0.01	338	19.72
			AVERAGE	0.034	0.028	0.5	0.01	339	19.67
E-85	MSU1631	HWFET	E-85 TEST 1	0.019	0.016	0.6	0.02	354	17.51
	MSU1632	HWFET	E-85 TEST 2	0.024	0.020	0.6	0.07	345	17.93
	MSU1633	HWFET	E-85 TEST 3	0.027	0.023	0.6	0.03	348	17.79
			AVERAGE	0.023	0.020	0.6	0.038	349	17.74

Table A-4. Chevrolet Impala Non-Flex-Fuel Emission and Fuel Economy Raw Data

Year	2007	Color : gray								
Make	Chevy									
Model	Impala	non flex								
Engine Family	7GMB03.5048	3.5 liter motor								
Evap Family	7GMXR0133810									
Test Weight	3875									
HP@50	11.5		NMOG = THC x 0.84							
Tier 2 Bin 5 Emissions Standards, grams/mile					0.090	4.2	0.07			
Fuel	Test Number	Test Name	Remarks	THC	NMOG	CO	NO _x	CO ₂	Fuel Economy	
Optimal	MSU	FTP 75	Optimal E-40	0.046	0.039	2.4	0.07	490	15.42	
Tier 2	MSU1802	FTP 75	Tier 2	0.092	0.077	2.4	0.05	544	16.19	
Tier 2	MSU1773	HWFET	E-0 Test 1	0.079	0.066	0.9	0.02	356	24.79	
	MSU1774	HWFET	E-0 Test 2	0.078	0.066	1.1	0.01	355	24.83	
	MSU1776	HWFET	E-0 Test 3	0.106	0.089	2.0	0.03	367	23.92	
	AVERAGE			0.088	0.074	1.3	0.02	360	24.51	
E-10	MSU1770	HWFET	E-10 Test 1	0.075	0.063	1.2	0.00	365	23.31	
	MSU1771	HWFET	E-10 Test 2	0.068	0.057	1.2	0.01	360	23.64	
	MSU1772	HWFET	E-10 Test 3	0.065	0.055	1.0	0.01	364	23.37	
	AVERAGE			0.069	0.058	1.2	0.01	363	23.44	
E-20	MSU1767	HWFET	E-20 Test 1	0.062	0.052	0.7	0.02	345	23.79	
	MSU1768	HWFET	E-20 Test 2	0.081	0.068	1.2	0.00	353	23.21	
	MSU1769	HWFET	E-20 Test 3	0.085	0.071	1.4	0.07	358	22.90	
	AVERAGE			0.076	0.064	1.1	0.03	352	23.30	
E-30	MSU1763	HWFET	E-30 Test 1	0.079	0.066	0.7	0.00	376	21.01	
	MSU1764	HWFET	E-30 Test 2	0.065	0.055	0.9	0.00	355	22.24	
	MSU1766	HWFET	E-30 Test 4	0.078	0.066	2.3	0.01	368	21.34	
	AVERAGE			0.074	0.062	1.3	0.00	366	21.53	
E-40	MSU1760	HWFET	E-40 Test 1	0.047	0.039	0.8	0.00	336	22.60	
	MSU1761	HWFET	E-40 Test 2	0.060	0.050	0.9	0.03	335	22.66	
	MSU1762	HWFET	E-40 Test 3	0.065	0.055	1.4	0.00	332	22.70	
	AVERAGE			0.057	0.048	1.0	0.01	334	22.65	
E-50	MSU1628	HWFET	E-50 Test 1	0.033	0.028	0.3	0.00	356	20.50	
	MSU1629	HWFET	E-50 Test 2	0.031	0.026	0.4	0.00	343	21.25	
	MSU1630	HWFET	E-50 Test 3	0.028	0.024	0.5	0.03	353	20.66	
	AVERAGE			0.031	0.026	0.4	0.01	351	20.803	

Table A-5. Ford Fusion Non-Flex-Fuel Emission and Fuel Economy Raw Data

Year	2007	Color:	red							
Make	Ford									
Model	Fusion									
Engine Family	7FMXV02.3VET	2.3 liter motor								
Evap Family	7FMXR0155GAK									
Test Weight	3625									
HP@50	13.4									
					NMOG = THC x 0.84					
Tier 2 Bin 5 Emissions Standards, grams/mile					0.090	4.2	0.07			
Fuel	Test Number	Test Name	Remarks	THC	NMOG	CO	NO _x	CO ₂	Fuel Economy	
Optimal	MSU	FTP 75	Optimal E30	0.013	0.011	0.7	0.01	435	18.19	
Tier 2	MSU1803	FTP 75	Tier 2	0.008	0.007	0.9	0.01	445	19.87	
Tier 2	MSU1726	HWFET	Tier 2 Test 1	0.004	0.003	0.3	0.00	332	26.71	
	MSU1727	HWFET	Tier 2 Test 2	0.003	0.003	0.2	0.00	322	27.49	
	MSU1728	HWFET	Tier 2 Test 3	0.004	0.003	0.3	0.00	332	26.70	
			AVERAGE	0.004	0.003	0.2	0.00	329	26.97	
E-10	MSU1706	HWFET	E-10 Test 1	0.000	0.000	0.6	0.02	365	23.37	
	MSU1707	HWFET	E-10 Test 2	0.000	0.000	0.4	0.02	359	23.79	
	MSU1708	HWFET	E-10 Test 3	0.000	0.000	0.5	0.00	364	23.48	
			AVERAGE	0.000	0.000	0.5	0.01	363	23.55	
E-20	MSU1689	HWFET	E-20 Test 1	0.000	0.000	0.4	0.00	323	25.45	
	MSU1690	HWFET	E-20 Test 2	0.005	0.004	0.4	0.00	315	26.13	
	MSU1691	HWFET	E-20 Test 3	0.000	0.000	0.5	0.00	318	25.85	
			AVERAGE	0.002	0.002	0.4	0.00	319	25.81	
E-30	MSU1675	HWFET	E-30 Test 1	0.007	0.006	0.2	0.00	294	26.97	
	MSU1676	HWFET	E-30 Test 2	0.007	0.006	0.2	0.00	289	27.40	
	MSU1678	HWFET	E-30 Test 3	0.005	0.004	0.2	0.00	293	27.04	
			AVERAGE	0.006	0.006	0.2	0.00	292	27.14	
E-40	MSU1652	HWFET	E-40 Test 1	0.000	0.000	0.4	0.01	355	21.44	
	MSU1653	HWFET	E-40 Test 2	0.002	0.002	0.5	0.01	346	21.94	
	MSU1654	HWFET	E-40 Test 3	0.000	0.000	0.4	0.00	337	22.58	
			AVERAGE	0.001	0.001	0.5	0.01	346	21.99	
E-45	MSU1636	HWFET	E-45 Test 1	0.002	0.002	0.5	0.00	346	21.51	
	MSU1637	HWFET	E-45 Test 3	0.001	0.001	0.5	0.00	356	20.9	
	MSU1638	HWFET	E-45 Test 3	0.002	0.002	0.5	0.00	353	21.08	
			AVERAGE	0.002	0.002	0.5	0.00	352	21.16	